

LPG Maxi KIT

Product Catalogue



VERSUS[®] **FHT**
AUTO GAS equipment

LPG Maxi KIT

We are designer, manufacturer and supplier of components and solutions for alternative fuels in the area of gas injection systems automotive conversions.

From this catalogue you will learn about our range of products we have on offer.

FHT VERSUSGAS offers conversion kits for vehicles both for **LPG** as well as **CNG** fuel.

Each **Maxi KIT** contains **Mini KIT** hardware plus all necessary mounting parts.

Main parts of LPG conversion KIT



V-Controller ECU



Standard VR-L reducer



FH02 injectors



High-power VR-L Super reducer

Each KIT consists of main parts, accessories and mounting hardware in various quantity and configurations. Maxi KIT does not consist GAS tank. It is upon the user and vehicle parameters which type of tank can be installed. Using wrong mounting hardware or third-party accessories can result in life / health hazard or technical malfunction. FHT VERSUSGAS does not take the responsibility for it.

LPG Maxi KIT

Gas conversion set for 4-cylinder engines

Product: V4LO/VRL/FH02-4/F1/PW/X14

Cat. no.: 1LO/1/1/1/1/1

The most popular KIT dedicated to **4-cylinder** engines up to **200 HP** power. FH02-4 cyl injector body determines that total length of $\varnothing 5$ mm gas hose between inlet manifold nozzles and calibration nozzles should not exceed 20 cm. Please assure that there is enough space to install FH02-4 injector.

Part name	Part number	Qty	
1a	ECU V4 OBD	EL.V4.OBD	1
1b	Harness P4 OBD	EL.P4.LO	1
1c	Map-sensor XFP1	EL.MAP.M	1
1d	Reducer's temp. sensor	EL.CTR	1
1e	Gas temp. STD sensor	EL.CTG.B	1
1f	Fuse 10A	EL.B.10A	1
1g	Fuse case	EL.B.OBB	1
1h	Change-over switch	EL.SW.OBD	1
1i	Spade connector	EL.AK.ZL.Z	2
1j	Ring connector	EL.AK.ZL.O	2
1k	Connector insulator	EL.AK.OB.EL	2
1l	T-fitting for vacuum	EL.AK.TRVAC	1
2	Reducer VR-L Standard with mounting KIT	RD.VL	1
3a	FH02 Injector body 4-cyl.	LW.4.BD	1
3b	Inlet manifold nozzle IM	LW.DKL	5
3c	FH02 damper	LW.DW	2
3d	Calibration nozzle 1.5 mm	LW.DK15	4
4	Filter 1-1 12 mm	F1	1
5	Sensor KIT	PW	1



Part name	Part number	Qty	
6a	Copper hose $\varnothing 6$ mm	MC.MD6	6 m
6b	Water hose $\varnothing 16$ mm	MC.WW16	1.6 m
6c	Gas hose $\varnothing 12$ mm	MC.WG12	0.8 m
6d	Gas hose $\varnothing 5$ mm	MC.WG5	1.8 m
6e	Vacuum hose $\varnothing 5$ mm	MC.WV5	1.5 m
6f	Water T-fitting 16/16/16 mm	MC.T-WOD.M16	2
6g	Metal clamp 12-22	MC.OP12-22	12
6h	Pressure hose clamp	MC.OPAML12	10
6i	Vacuum clamp	MC.OP5V	6
6j	Copper pipe support	MC.M	10



www.versusgas.com

+48 25 759 42 61

info@versusgas.com

VERSUS[®]
AUTO GAS equipment

FHT

FHT Export-Import
ul. Szczecinska 16G
05-300 Minsk Mazowiecki, POLAND

LPG Maxi KIT

Gas conversion set for 4-cylinder engines

Product: V4LO/VRL/2XFH02-2/F2/PW/X22M

Cat. no.: 1LO/1/3/2/1/3M

The most popular KIT dedicated to **4-cylinder** engines up to **200 HP** power. KIT dedicated to boxer type engines. 2 pcs of Injector FH02 2 cyl. are included. Those injectors can be installed close to the inlet manifold nozzles, and short distance between inlet manifold nozzles and calibration nozzles can be preserved.

Part name	Part number	Qty	
1a	ECU V4 OBD	EL.V4.OBD	1
1b	Harness P4 OBD	EL.P4.LO	1
1c	Map-sensor XFP1	EL.MAP.M	1
1d	Reducer's temp. sensor	EL.CTR	1
1e	Gas temp. STD sensor	EL.CTG.B	1
1f	Fuse 10A	EL.B.10A	1
1g	Fuse case	EL.B.OBB	1
1h	Change-over switch	EL.SW.OBD	1
1i	Spade connector	EL.AK.ZL.Z	2
1j	Ring connector	EL.AK.ZL.O	2
1k	Connector insulator	EL.AK.OB.EL	2
1l	T-fitting for vacuum	EL.AK.TRVAC	1
2	Reducer VR-L Standard with mounting KIT	RD.VL	1
3a	FH02 Injector body 2-cyl.	LW.2.BD	2
3b	Inlet manifold nozzle IM	LW.DKL	5
3c	FH02 damper	LW.DW	2
3d	Calibration nozzle 1.5 mm	LW.DK15	4
4	Filter 1-2 12 mm	F2	1
5	Sensor KIT	PW	1



Part name	Part number	Qty	
6a	Copper hose o6 mm	MC.MD6	6 m
6b	Water hose o16 mm	MC.WW16	1.6 m
6c	Gas hose o12 mm	MC.WG12	1.5 m
6d	Gas hose o5 mm	MC.WG5	1.8 m
6e	Vacuum hose o5 mm	MC.WV5	1.5 m
6f	Water T-fitting 16/16/16 mm	MC.T-WOD.M16	2
6g	Metal clamp 12-22	MC.OP12-22	14
6h	Pressure hose clamp	MC.OPAML12	10
6i	Vacuum clamp	MC.OP5V	6
6j	Copper pipe support	MC.M	10



www.versusgas.com

+48 25 759 42 61

info@versusgas.com

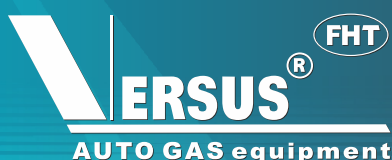

FHT Export-Import
ul. Szczecińska 16G
05-300 Minsk Mazowiecki, POLAND

LPG Maxi KIT

Gas conversion set for 4-cylinder engines

Product: V4LO.3/VRL/4XFH02-1/F4.12/PW/X41N

Cat. no.: 1LO/3/1/2/4/1/2N

The most popular KIT dedicated to **4-cylinder** engines up to **200 HP** power. Separate FH02-1 cyl. injectors can be installed very close to the inlet manifold nozzles. Final length of o5 mm gas hose between inlet manifold nozzles and calibration nozzles can be very short. Kit dedicated to cars where FH02-4 cyl. injectors cannot be installed.

Part name	Part number	Qty	
1a	ECU V4 OBD	EL.V4.OBD	1
1b	Harness P4 OBD	EL.P4.LO	1
1c	Map-sensor XFP1	EL.MAP.M	1
1d	Reducer's temp. sensor	EL.CTR	1
1e	Gas temp. STD sensor	EL.CTG.B	1
1f	Fuse 10A	EL.B.10A	1
1g	Fuse case	EL.B.OBB	1
1h	Change-over switch	EL.SW.OBD	1
1i	Spade connector	EL.AK.ZL.Z	2
1j	Ring connector	EL.AK.ZL.O	2
1k	Connector insulator	EL.AK.OB.EL	2
1l	T-fitting for vacuum	EL.AK.TRVAC	1
2	Reducer VR-L Standard with mounting KIT	RD.VL	1
3a	FH02 Injector body 1-cyl.	LW.1.BD	4
3b	Inlet manifold nozzle IM	LW.DKL	4
3c	Calibration nozzle 1.5 mm	LW.DK15	4
4	Filter 1-4 12/7 mm	F4.12.2	1
5	Sensor KIT	PW	1



Part name	Part number	Qty	
6a	Copper hose o6 mm	MC.MD6	6 m
6b	Water hose o16 mm	MC.WW16	1.6 m
6c	Gas hose o12 mm	MC.WG12	0.8 m
6d	Gas hose o5 mm	MC.WG5	1.8 m
6e	Gas hose o6 mm	MC.WG6	1.6 m
6f	Vacuum hose o5 mm	MC.WV5	1.5 m
6g	Water T-fitting 16/16/16 mm	MC.T-WOD.M16	2
6h	Metal clamp 12-22	MC.OP12-22	12
6i	Metal clamp 8-12	MC.OP8-12	8
6j	Pressure hose clamp	MC.OPAML12	10
6k	Vacuum clamp	MC.OP5V	6
6l	Copper pipe support	MC.M	10
6m	Inlet manifold nozzle IM	LW.DKL	1



www.versusgas.com

+48 25 759 42 61

info@versusgas.com

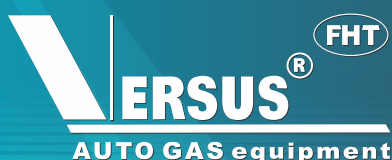

FHT Export-Import
ul. Szczecinska 16G
05-300 Minsk Mazowiecki, POLAND

LPG Maxi KIT

Gas conversion set for 4-cylinder engines

Product: V4LO/VRL-S/FH02-4/F1/PW/X148

Cat. no.: 1LO/2/1/1/1/18

The most popular KIT dedicated to **4-cylinder** engines **over 200 HP** power. FH02-4 cyl injector body determines that total length of $\varnothing 5$ mm gas hose between inlet manifold nozzles and calibration nozzles should not exceed 20 cm. KIT dedicated especially for turbo-charged engines. **Important:** only high flow Multivalve (often called „Extra” 8 mm outlet version) shall be used together with this KIT.

Part name	Part number	Qty	
1a	ECU V4 OBD	EL.V4.OBD	1
1b	Harness P4 OBD	EL.P4.LO	1
1c	Map-sensor XFP1	EL.MAP.M	1
1d	Reducer's temp. sensor	EL.CTR	1
1e	Gas temp. STD sensor	EL.CTG.B	1
1f	Fuse 10A	EL.B.10A	1
1g	Fuse case	EL.B.OBB	1
1h	Change-over switch	EL.SW.OBD	1
1i	Spade connector	EL.AK.ZL.Z	2
1j	Ring connector	EL.AK.ZL.O	2
1k	Connector insulator	EL.AK.OB.EL	2
1l	T-fitting for vacuum	EL.AK.TRVAC	1
2	Reducer VR-L Super with mounting KIT	RD.VLS	1
3a	FH02 Injector body 4-cyl.	LW.4.BD	1
3b	Inlet manifold nozzle IM	LW.DKL	5
3c	FH02 damper	LW.DW	2
3d	Calibration nozzle 1.5 mm	LW.DK15	4
4	Filter 1-1 12 mm	F1	1
5	Sensor KIT	PW	1



Part name	Part number	Qty	
6a	Copper hose $\varnothing 6$ mm	MC.MD6	6 m
6b	Water hose $\varnothing 16$ mm	MC.WW16	1.6 m
6c	Gas hose $\varnothing 12$ mm	MC.WG12	0.8 m
6d	Gas hose $\varnothing 5$ mm	MC.WG5	1.8 m
6e	Vacuum hose $\varnothing 5$ mm	MC.WV5	1.5 m
6f	Water T-fitting 16/16/16 mm	MC.T-WOD.M16	2
6g	Metal clamp 12-22	MC.OP12-22	12
6h	Pressure hose clamp	MC.OPAML12	10
6i	Vacuum clamp	MC.OP5V	6
6j	Copper pipe support	MC.M	10



www.versusgas.com

+48 25 759 42 61

info@versusgas.com

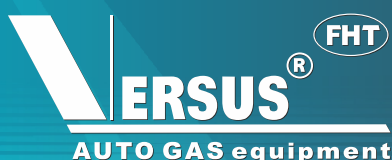

FHT Export-Import
ul. Szczecinska 16G
05-300 Minsk Mazowiecki, POLAND

LPG Maxi KIT

Gas conversion set for 4-cylinder engines

Product: V4LO/VRL-S/4XFH02-1/F4.12/PW/X4180

Cat. no.: 1LO/3/2/2/4/1/280

The most popular KIT dedicated to **4-cylinder** engines **over 200 HP** power. Separate FH02-1 cyl. injectors can be installed very close to the inlet manifold nozzles. Final length of o5 mm gas hose between inlet manifold nozzles and calibration nozzles can be very short. Kit dedicated to cars where FH02-4 cyl. injectors cannot be installed. KIT dedicated especially for turbo-charged engines. **Important:** only high flow Multivalve (often called „Extra” 8 mm outlet version) shall be used together with this KIT.

Part name	Part number	Qty
1a	ECU V4 OBD	EL.V4.OBD 1
1b	Harness P4 OBD	EL.P4.LO 1
1c	Map-sensor XFP1	EL.MAP.M 1
1d	Reducer's temp. sensor	EL.CTR 1
1e	Gas temp. STD sensor	EL.CTG.B 1
1f	Fuse 10A	EL.B.10A 1
1g	Fuse case	EL.B.OBB 1
1h	Change-over switch	EL.SW.OBD 1
1i	Spade connector	EL.AK.ZL.Z 2
1j	Ring connector	EL.AK.ZL.O 2
1k	Connector insulator	EL.AK.OB.EL 2
1l	T-fitting for vacuum	EL.AK.TRVAC 1
2	Reducer VR-L Super with mounting KIT	RD.VLS 1
3a	FH02 Injector body 1-cyl.	LW.1.BD 4
3b	Inlet manifold nozzle IM	LW.DKL 4
3c	Calibration nozzle 1.5 mm	LW.DK15 4
4	Filter 1-4 12/7 mm	F4.12.2 1
5	Sensor KIT	PW 1



Part name	Part number	Qty
6a	Copper hose o6 mm	MC.MD6 6 m
6b	Water hose o16 mm	MC.WW16 1.6 m
6c	Gas hose o12 mm	MC.WG12 0.8 m
6d	Gas hose o5 mm	MC.WG5 1.8 m
6e	Gas hose o6 mm	MC.WG6 1.6 m
6f	Vacuum hose o5 mm	MC.WV5 1.5 m
6g	Water T-fitting 16/16/16 mm	MC.T-WOD.M16 2
6h	Metal clamp 12-22	MC.OP12-22 12
6i	Metal clamp 8-12	MC.OP8-12 8
6j	Pressure hose clamp	MC.OPAML12 10
6k	Vacuum clamp	MC.OP5V 6
6l	Copper pipe support	MC.M 10
6m	Inlet manifold nozzle IM	LW.DKL 1



www.versusgas.com

+48 25 759 42 61

info@versusgas.com

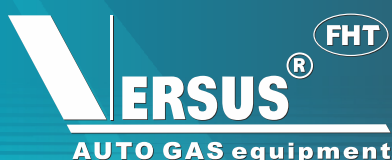

FHT Export-Import
ul. Szczecinska 16G
05-300 Minsk Mazowiecki, POLAND

LPG Maxi KIT

Gas conversion set for 6-cylinder engines

Product: V6LO/VRL/2XFH02-3/F2/PW/X23H

Cat. no.: 6LO/1/4/2/1/4H

The most popular KIT dedicated to **6-cylinder** engines up to **200 HP** power.
2 pcs of Injector FH02 3 cyl. are included.

Part name	Part number	Qty	
1a	ECU V6 OBD	EL.V6.OBD	1
1b	Harness P6 OBD	EL.P6.LO	1
1c	Map-sensor XFP1	EL.MAP.M	1
1d	Reducer's temp. sensor	EL.CTR	1
1e	Gas temp. STD sensor	EL.CTG.B	1
1f	Fuse 10A	EL.B.10A	1
1g	Fuse case	EL.B.OBB	1
1h	Change-over switch	EL.SW.OBD	1
1i	Spade connector	EL.AK.ZL.Z	2
1j	Ring connector	EL.AK.ZL.O	2
1k	Connector insulator	EL.AK.OB.EL	2
1l	T-fitting for vacuum	EL.AK.TRVAC	1
2	Reducer VR-L Standard with mounting KIT	RD.VL	1
3a	FH02 Injector body 3-cyl.	LW.3.BD	2
3b	Inlet manifold nozzle IM	LW.DKL	7
3c	FH02 damper	LW.DW	4
3d	Calibration nozzle 1.5 mm	LW.DK15	6
4	Filter 1-2 12 mm	F2	1
5	Sensor KIT	PW	1



Part name	Part number	Qty	
6a	Copper hose o6 mm	MC.MD6	6 m
6b	Water hose o16 mm	MC.WW16	2 m
6c	Gas hose o12 mm	MC.WG12	1.5 m
6d	Gas hose o5 mm	MC.WG5	2.8 m
6e	Vacuum hose o5 mm	MC.WV5	1.5 m
6f	Water T-fitting 16/16/16 mm	MC.T-WOD.M16	2
6g	Metal clamp 12-22	MC.OP12-22	14
6h	Pressure hose clamp	MC.OPAML12	14
6i	Vacuum clamp	MC.OP5V	6
6j	Copper pipe support	MC.M	10



www.versusgas.com

+48 25 759 42 61

info@versusgas.com

VERSUS[®]
AUTO GAS equipment

FHT Export-Import
ul. Szczecińska 16G
05-300 Minsk Mazowiecki, POLAND

LPG Maxi KIT

Gas conversion set for 6-cylinder engines

Product: V6LO/VRL-S/FH02-3/F1.1/PW/X23J

Cat. no.: 6LO/2/4/11/1/4J

The most popular KIT dedicated to **6-cylinder** engines **over 200 HP** power. 2 pcs of Injector FH02-3 cyl. included.
Important: only high flow Multivalve (often called „Extra” 8 mm outlet version) shall be used together with this KIT.

Part name	Part number	Qty	
1a	ECU V6 OBD	EL.V6.OBD	1
1b	Harness P6 OBD	EL.P6.LO	1
1c	Map-sensor XFP1	EL.MAP.M	1
1d	Reducer's temp. sensor	EL.CTR	1
1e	Gas temp. STD sensor	EL.CTG.B	1
1f	Fuse 10A	EL.B.10A	1
1g	Fuse case	EL.B.OBB	1
1h	Change-over switch	EL.SW.OBD	1
1i	Spade connector	EL.AK.ZL.Z	2
1j	Ring connector	EL.AK.ZL.O	2
1k	Connector insulator	EL.AK.OB.EL	2
1l	T-fitting for vacuum	EL.AK.TRVAC	1
2	Reducer VR-L Super with mounting KIT	RD.VLS	1
3a	FH02 Injector body 3-cyl.	LW.3.BD	2
3b	Inlet manifold nozzle IM	LW.DKL	7
3c	FH02 damper	LW.DW	4
3d	Calibration nozzle 1.5 mm	LW.DK15	6
4a	Filter 1-2 12 mm	F2	2
4b	Gas Y-fitting	F.Y	1
5	Sensor KIT	PW	1



Part name	Part number	Qty	
6a	Copper hose o8 mm	MC.MD8	6 m
6b	Water hose o16 mm	MC.WW16	2 m
6c	Gas hose o12 mm	MC.WG12	1.5 m
6d	Gas hose o5 mm	MC.WG5	2.8 m
6e	Vacuum hose o5 mm	MC.WV5	1.5 m
6f	Water T-fitting 16/16/16 mm	MC.T-WOD.M16	2
6g	Metal clamp 12-22	MC.OP12-22	18
6h	Pressure hose clamp	MC.OPAML12	14
6i	Vacuum clamp	MC.OP5V	6
6j	Copper pipe support	MC.M	10



www.versusgas.com

+48 25 759 42 61

info@versusgas.com

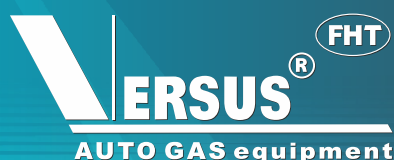

FHT Export-Import
 ul. Szczecińska 16G
 05-300 Minsk Mazowiecki, POLAND

LPG Maxi KIT

Gas conversion set for 6-cylinder engines

Product: V6LO/VRL-S/6XFH02-1/F2.3/PW/X61

Cat. no.: 6LO/3/2/8/23/1/4C

The most popular KIT dedicated to **6-cylinder** engines **over 200 HP** power. 6 pcs of Injector FH02-1 cyl. included.
Important: only high flow Multivalve (often called „Extra” 8 mm outlet version) shall be used together with this KIT.

Part name	Part number	Qty	
1a	ECU V6 OBD	EL.V6.OBD	1
1b	Harness P6 OBD	EL.P6.LO	1
1c	Map-sensor XFP1	EL.MAP.M	1
1d	Reducer's temp. sensor	EL.CTR	1
1e	Gas temp. STD sensor	EL.CTG.B	1
1f	Fuse 10A	EL.B.10A	1
1g	Fuse case	EL.B.OBB	1
1h	Change-over switch	EL.SW.OBD	1
1i	Spade connector	EL.AK.ZL.Z	2
1j	Ring connector	EL.AK.ZL.O	2
1k	Connector insulator	EL.AK.OB.EL	2
1l	T-fitting for vacuum	EL.AK.TRVAC	1
2	Reducer VR-L Super with mounting KIT	RD.VLS	1
3a	FH02 Injector body 1-cyl.	LW.1.BD	6
3b	Inlet manifold nozzle IM	LW.DKL	6
3c	Calibration nozzle 1.5 mm	LW.DK15	6
4a	Filter 1-3 12/7 mm	F3	2
4b	Gas Y-fitting	F.Y	1
5	Sensor KIT	PW	1



Part name	Part number	Qty	
6a	Copper hose o8 mm	MC.MD8	6 m
6b	Water hose o16 mm	MC.WW16	2 m
6c	Gas hose o12 mm	MC.WG12	1.5 m
6d	Gas hose o5 mm	MC.WG5	2.8 m
6e	Gas hose o6 mm	MC.WG6	3 m
6f	Vacuum hose o5 mm	MC.WV5	1.5 m
6g	Water T-fitting 16/16/16 mm	MC.T-WOD.M16	2
6h	Metal clamp 12-22	MC.OP12-22	16
6i	Metal clamp 8-12	MC.OP8-12	12
6j	Pressure hose clamp	MC.OPAML12	14
6k	Vacuum clamp	MC.OP5V	6
6l	Copper pipe support	MC.M	10
6m	Inlet manifold nozzle IM	LW.DKL	1



www.versusgas.com

+48 25 759 42 61

info@versusgas.com

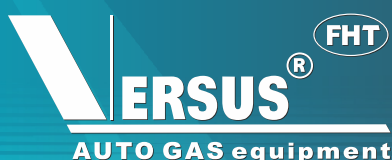

FHT Export-Import
 ul. Szczecinska 16G
 05-300 Minsk Mazowiecki, POLAND

LPG Maxi KIT

Gas conversion set for 8-cylinder engines

Product: V8LO/VRL-S/2XFH02-4/F1.1/PW/X24A

Cat. no.: 8LO/2/5/11/1/5A

The most popular KIT dedicated to **8-cylinder** engines **up to 300 HP** power. 2 pcs of Injector FH02-4 cyl. included.
Important: only high flow Multivalve (often called „Extra” 8 mm outlet version) shall be used together with this KIT.

Part name	Part number	Qty
1a ECU V8 OBD	EL.V8.OBD	1
1b Harness P8 OBD	EL.P8.LO	1
1c Map-sensor XFP1	EL.MAP.M	1
1d Reducer's temp. sensor	EL.CTR	1
1e Gas temp. STD sensor	EL.CTG.B	1
1f Fuse 10A	EL.B.10A	1
1g Fuse case	EL.B.OBB	1
1h Change-over switch	EL.SW.OBD	1
1i Spade connector	EL.AK.ZL.Z	2
1j Ring connector	EL.AK.ZL.O	2
1k Connector insulator	EL.AK.OB.EL	2
1l T-fitting for vacuum	EL.AK.TRVAC	1
2 Reducer VR-L Super with mounting KIT	RD.VLS	1
3a FH02 Injector body 4-cyl.	LW.4.BD	2
3b Inlet manifold nozzle IM	LW.DKL	10
3c FH02 damper	LW.DW	4
3d Calibration nozzle 1.5 mm	LW.DK15	8
4a Filter 1-1 12 mm	F1	2
4b Gas Y-fitting	F.Y	1
5 Sensor KIT	PW	1



Part name	Part number	Qty
6a Copper hose o8 mm	MC.MD8	6 m
6b Water hose o16 mm	MC.WW16	2 m
6c Gas hose o12 mm	MC.WG12	1.8 m
6d Gas hose o5 mm	MC.WG5	3.2 m
6e Vacuum hose o5 mm	MC.WV5	1.5 m
6f Water T-fitting 16/16/16 mm	MC.T-WOD.M16	2
6g Metal clamp 12-22	MC.OP12-22	18
6h Pressure hose clamp	MC.OPAML12	18
6i Vacuum clamp	MC.OP5V	6
6j Copper pipe support	MC.M	10



www.versusgas.com

+48 25 759 42 61

info@versusgas.com

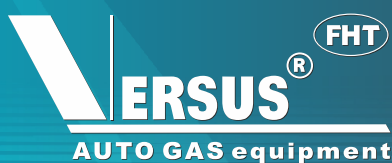

FHT Export-Import
 ul. Szczecinska 16G
 05-300 Minsk Mazowiecki, POLAND

LPG Maxi KIT

Gas conversion set for 8-cylinder engines

Product: V8LO/VRL-S/4XFH02-2/F1.1/PW/X42U

Cat. no.: 8LO/2/7/11/1/5U

The most popular KIT dedicated to **8-cylinder** engines **up to 300 HP** power. 4 pcs of Injector FH02-2 cyl. included.
Important: only high flow Multivalve (often called „Extra” 8 mm outlet version) shall be used together with this KIT.

Part name	Part number	Qty
1a ECU V8 OBD	EL.V8.OBD	1
1b Harness P8 OBD	EL.P8.LO	1
1c Map-sensor XFP1	EL.MAP.M	1
1d Reducer's temp. sensor	EL.CTR	1
1e Gas temp. STD sensor	EL.CTG.B	1
1f Fuse 10A	EL.B.10A	1
1g Fuse case	EL.B.OBB	1
1h Change-over switch	EL.SW.OBD	1
1i Spade connector	EL.AK.ZL.Z	2
1j Ring connector	EL.AK.ZL.O	2
1k Connector insulator	EL.AK.OB.EL	2
1l T-fitting for vacuum	EL.AK.TRVAC	1
2 Reducer VR-L Super with mounting KIT	RD.VLS	1
3a FH02 Injector body 2-cyl.	LW.2.BD	4
3b Inlet manifold nozzle IM	LW.DKL	10
3c FH02 damper	LW.DW	4
3d Calibration nozzle 1.5 mm	LW.DK15	8
4a Filter 1-1 12 mm	F1	2
4b Gas Y-fitting	F.Y	1
5 Sensor KIT	PW	1



Part name	Part number	Qty
6a Copper hose o8 mm	MC.MD8	8 m
6b Water hose o16 mm	MC.WW16	4 m
6c Gas hose o12 mm	MC.WG12	3 m
6d Gas hose o5 mm	MC.WG5	6 m
6e Vacuum hose o5 mm	MC.WV5	3 m
6f Water T-fitting 16/16/16 mm	MC.T-WOD.M16	2
6g Metal clamp 12-22	MC.OP12-22	22
6h Pressure hose clamp	MC.OPAML12	18
6i Vacuum clamp	MC.OP5V	6
6j Copper pipe support	MC.M	14
6k Outlet nozzle 12 mm	RD.00-37	2



www.versusgas.com

+48 25 759 42 61

info@versusgas.com

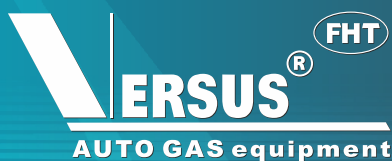

FHT Export-Import
 ul. Szczecinska 16G
 05-300 Minsk Mazowiecki, POLAND

LPG Maxi KIT

Gas conversion set for 8-cylinder engines

Product: V8LO/VRL-S/8XFH02-1/2XF4/PW/X81W

Cat. no.: 8LO3/2/9/24/1/5W

The most popular KIT dedicated to **8-cylinder** engines **up to 300 HP** power. 8 pcs of Injector FH02-1 cyl. included.
Important: only high flow Multivalve (often called „Extra” 8 mm outlet version) shall be used together with this KIT.

Part name	Part number	Qty	
1a	ECU V8 OBD	EL.V8.OBD	1
1b	Harness P8 OBD	EL.P8.LO	1
1c	Map-sensor XFP1	EL.MAP.M	1
1d	Reducer's temp. sensor	EL.CTR	1
1e	Gas temp. STD sensor	EL.CTG.B	1
1f	Fuse 10A	EL.B.10A	1
1g	Fuse case	EL.B.OBB	1
1h	Change-over switch	EL.SW.OBD	1
1i	Spade connector	EL.AK.ZL.Z	2
1j	Ring connector	EL.AK.ZL.O	2
1k	Connector insulator	EL.AK.OB.EL	2
1l	T-fitting for vacuum	EL.AK.TRVAC	1
2	Reducer VR-L Super with mounting KIT	RD.VLS	1
3a	FH02 Injector body 2-cyl.	LW.2.BD	4
3b	Inlet manifold nozzle IM	LW.DKL	10
3c	FH02 damper	LW.DW	4
3d	Calibration nozzle 1.5 mm	LW.DK15	8
4a	Filter 1-1 12 mm	F1	2
4b	Gas Y-fitting	F.Y	1
5	Sensor KIT	PW	1



Part name	Part number	Qty	
6a	Copper hose o8 mm	MC.MD8	8 m
6b	Water hose o16 mm	MC.WW16	4 m
6c	Gas hose o12 mm	MC.WG12	3 m
6d	Gas hose o5 mm	MC.WG5	8 m
6e	Gas hose o6 mm	MC.WG6	8 m
6f	Vacuum hose o5 mm	MC.WV5	3 m
6g	Water T-fitting 16/16/16 mm	MC.T-WOD.M16	2
6h	Metal clamp 12-22	MC.OP12-22	16
6i	Metal clamp 8-12	MC.OP8-12	16
6j	Pressure hose clamp	MC.OPAML12	18
6k	Vacuum clamp	MC.OP5V	6
6l	Copper pipe support	MC.M	14
6m	Outlet nozzle 12 mm	RD.00-37	1



www.versusgas.com

+48 25 759 42 61

info@versusgas.com

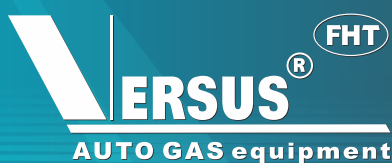

FHT Export-Import
 ul. Szczecinska 16G
 05-300 Minsk Mazowiecki, POLAND

LPG Maxi KIT

Gas conversion set for 8-cylinder engines

Product: V8LO.6/2VRL/2XFH02-4/F1/PW/X24X

Cat. no.: 8LO6/12/5/21/1/5X

Powerful KIT dedicated to **8-cylinder** engines in **300-400 HP** power range. 2 pcs of Standard Reducers included.
Important: only high flow Multivalve (often called „Extra” 8 mm outlet version) shall be used together with this KIT.

Part name	Part number	Qty
1a ECU V8 OBD	EL.V8.OBD	1
1b Harness P8 OBD	EL.P8.LO	1
1c Map-sensor XFP1	EL.MAP.M	1
1d Reducer's temp. sensor	EL.CTR	1
1e Gas temp. STD sensor	EL.CTG.B	1
1f Fuse 10A	EL.B.10A	1
1g Fuse case	EL.B.OBB	1
1h Change-over switch	EL.SW.OBD	1
1i Spade connector	EL.AK.ZL.Z	2
1j Ring connector	EL.AK.ZL.O	2
1k Connector insulator	EL.AK.OB.EL	2
1l T-fitting for vacuum	EL.AK.TRVAC	1
2a Reducer VR-L with mounting KIT	RD.VL	2
2b Gas T-fitting 6/8/6mm set	MC.TFIT686SET	1
3a FH02 Injector body 4-cyl.	LW.4.BD	2
3b Inlet manifold nozzle IM	LW.DKL	10
3c FH02 damper	LW.DW	4
3d Calibration nozzle 1.5 mm	LW.DK15	8
4 Filter 1-1 12 mm	F1	2
5 Sensor KIT	PW	1

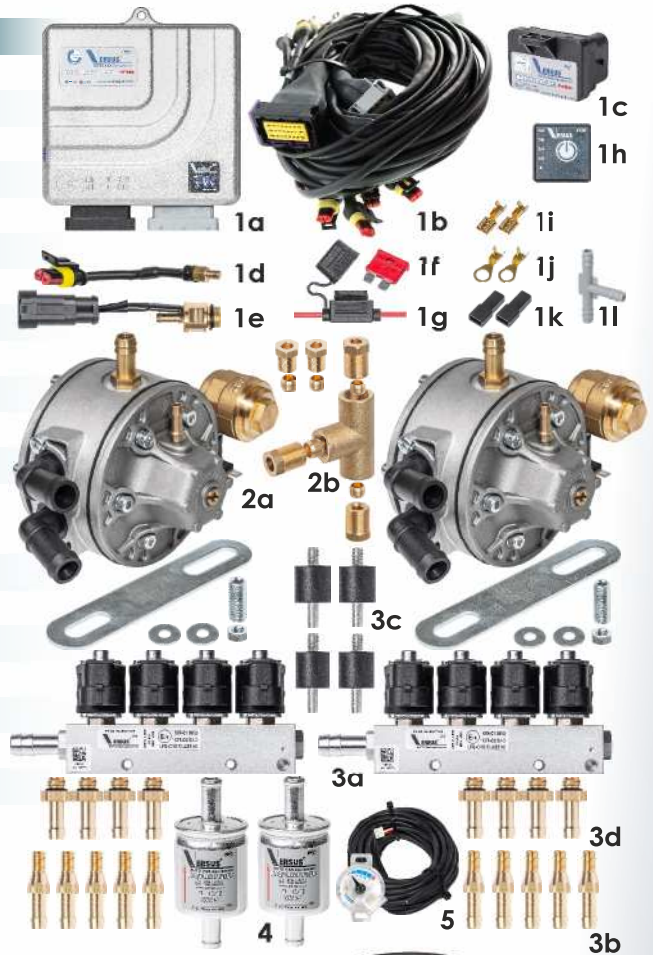

Part name	Part number	Qty
6a Copper hose o8 mm	MC.MD8	6 m
6b Copper hose o6 mm	MC.MD6	1.5 m
6c Water hose o16 mm	MC.WW16	3 m
6d Gas hose o12 mm	MC.WG12	2.5 m
6e Gas hose o5 mm	MC.WG5	3.2 m
6f Vacuum hose o5 mm	MC.WV5	1.5 m
6g Water T-fitting 16/16/16 mm	MC.T-WOD.M16	2
6h Metal clamp 12-22	MC.OP12-22	22
6i Pressure hose clamp	MC.OPAML12	18
6j Vacuum clamp	MC.OP5V	6
6k Copper pipe support	MC.M	10



www.versusgas.com

+48 25 759 42 61

info@versusgas.com

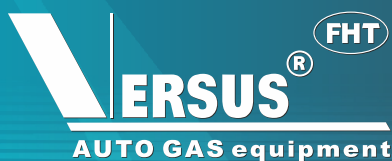

FHT Export-Import
 ul. Szczecinska 16G
 05-300 Minsk Mazowiecki, POLAND

LPG Maxi KIT

Gas conversion set for 8-cylinder engines

Product: V8LO.7/2VRL/4XFH02-2/2XF1/PW/X42F

Cat. no.: 8LO7/12/7/21/1/5F

Powerful KIT dedicated to **8-cylinder** engines in **300-400 HP** power range. 2 pcs of Standard Reducers included.
Important: only high flow Multivalve (often called „Extra” 8 mm outlet version) shall be used together with this KIT.

Part name	Part number	Qty
1a ECU V8 OBD	EL.V8.OBD	1
1b Harness P8 OBD	EL.P8.LO	1
1c Map-sensor XFP1	EL.MAP.M	1
1d Reducer's temp. sensor	EL.CTR	1
1e Gas temp. STD sensor	EL.CTG.B	1
1f Fuse 10A	EL.B.10A	1
1g Fuse case	EL.B.OBB	1
1h Change-over switch	EL.SW.OBD	1
1i Spade connector	EL.AK.ZL.Z	2
1j Ring connector	EL.AK.ZL.O	2
1k Connector insulator	EL.AK.OB.EL	2
1l T-fitting for vacuum	EL.AK.TRVAC	2
2a Reducer VR-L with mounting KIT	RD.VL	2
2b Gas T-fitting 6/8/6mm set	MC.TFIT686SET	1
3a FH02 Injector body 2-cyl.	LW.4.BD	4
3b Inlet manifold nozzle IM	LW.DKL	10
3c FH02 damper	LW.DW	4
3d Calibration nozzle 1.5 mm	LW.DK15	8
4a Filter 1-1 12 mm	F1	2
4b Gas Y-Fitting	F.Y	2
5 Sensor KIT	PW	1



Part name	Part number	Qty
6a Copper hose o8 mm	MC.MD8	8 m
6b Copper hose o6 mm	MC.MD6	2 m
6c Water hose o16 mm	MC.WW16	6 m
6d Gas hose o12 mm	MC.WG12	6 m
6e Gas hose o5 mm	MC.WG5	9 m
6f Vacuum hose o5 mm	MC.WV5	5 m
6g Water T-fitting 16/16/16 mm	MC.T-WOD.M16	2
6h Metal clamp 12-22	MC.OP12-22	28
6i Pressure hose clamp	MC.OPAML12	18
6j Vacuum clamp	MC.OP5V	10
6k Copper pipe support	MC.M	14



www.versusgas.com

+48 25 759 42 61

info@versusgas.com

LPG Maxi KIT

Gas conversion set for 8-cylinder engines

Product: V8LO.6/2VRL/8XFH02-1/2XF4/PW/X81G

Cat. no.: 8LO6/12/9/24/1/5G

Powerful KIT dedicated to **8-cylinder** engines in **300-400 HP** power range. 2 pcs of Standard Reducers included.
Important: only high flow Multivalve (often called „Extra” 8 mm outlet version) shall be used together with this KIT.

Part name	Part number	Qty
1a ECU V8 OBD	EL.V8.OBD	1
1b Harness P8 OBD	EL.P8.LO	1
1c Map-sensor XFP1	EL.MAP.M	1
1d Reducer's temp. sensor	EL.CTR	1
1e Gas temp. STD sensor	EL.CTG.B	1
1f Fuse 10A	EL.B.10A	1
1g Fuse case	EL.B.OBB	1
1h Change-over switch	EL.SW.OBD	1
1i Spade connector	EL.AK.ZL.Z	2
1j Ring connector	EL.AK.ZL.O	2
1k Connector insulator	EL.AK.OB.EL	2
1l T-fitting for vacuum	EL.AK.TRVAC	2
2a Reducer VR-L Super with mounting KIT	RD.VLS	2
2b Gas T-fitting 6/8/6mm set	MC.TFIT686SET	1
3a FH02 Injector body 1-cyl.	LW.1.BD	8
3b Inlet manifold nozzle IM	LW.DKL	8
3c Calibration nozzle 1.5 mm	LW.DK15	8
4a Filter 1-4 12/7 mm	F4	2
4b Gas Y-Fitting	F.Y	2
5 Sensor KIT	PW	1

Part name	Part number	Qty
6a Copper hose o8 mm	MC.MD8	8 m
6b Copper hose o6 mm	MC.MD6	2 m
6c Water hose o16 mm	MC.WW16	6 m
6d Gas hose o12 mm	MC.WG12	5m
6e Gas hose o5 mm	MC.WG5	8 m
6f Gas hose o6 mm	MC.WG6	8 m
6g Vacuum hose o5 mm	MC.WV5	5 m
6h Water T-fitting 16/16/16 mm	MC.T-WOD.M16	2
6i Metal clamp 12-22	MC.OP12-22	22
6j Metal clamp 8-12	MC.OP8-12	16
6k Pressure hose clamp	MC.OPAML12	18
6l Vacuum clamp	MC.OP5V	10
6m Copper pipe support	MC.M	14
6n Inlet manifold nozzle IM	LW.DKL	1



www.versusgas.com

+48 25 759 42 61

info@versusgas.com

VERSUS[®]
 AUTO GAS equipment

FHT

FHT Export-Import
 ul. Szczecińska 16G
 05-300 Minsk Mazowiecki, POLAND



We offer full assortment of Gas installation parts and accessories.
Detailed catalogue will be sent upon the request.
For more details please contact us:



Orders: sales@versusgas.com
Inquiries info@versusgas.com
Website: www.versusgas.com

FHT Versus Gas reserves the right to make any modification/improvement into its products at any time on the basis of its own assessment, without prior notice. The pictures, descriptions, product codes, technical data that are contained in this catalog are the property of FHT Versus Gas. Copying of this property is prohibited without prior written permission.

www.versusgas.com

| +48 25 759 42 61

| info@versusgas.com

 **VERSUS**[®] 
AUTO GAS equipment

FHT Export-Import
ul. Szczecińska 16G
05-300 Minsk Mazowiecki, POLAND